

◇ STRUCTURE Silicon Monolithic Integrated Circuit

◇ PRODUCT SPI BUS 2Kbit (256 × 8bit) EEPROM

◇ PART NUMBER BR25L020-W Series

PART NUMBER	PACKAGE
BR25L020F-W	SOP8
BR25L020FJ-W	SOP-J8
BR25L020FV-W	SSOP-B8
BR25L020FVT-W	TSSOP-B8
BR25L020FVM-W	MSOP8
BR25L020FVJ-W	TSSOP-B8J

◇ FEATURES Serial Peripheral Interface
 Single power supply (1.8V~5.5V)
 1,000,000 erase/write cycles endurance

◇ ABSOLUTE MAXIMUM RATING (Ta=25°C)

Parameter	Symbol	Rating	Unit
Supply Voltage	Vcc	-0.3~6.5	V
Power Dissipation	Pd	450 (BR25L020F-W) *1	mW
		450 (BR25L020FJ-W) *2	
		300 (BR25L020FV-W) *3	
		330 (BR25L020FVT-W) *4	
		310 (BR25L020FVM-W) *5	
		310 (BR25L020FVJ-W) *6	
Storage Temperature	Tstg	-65~125	°C
Operating Temperature	Topr	-40~85	°C
Terminal Voltage	-	-0.3~Vcc+0.3	V

* Degradation is done at 4.5mW/°C(*1,*2), 3.0mW/°C(*3), 3.3mW/°C(*4), 3.1mW/°C(*5,*6) for operation above 25°C

◇ RECOMMENDED OPERATING CONDITION

Parameter	Symbol	Rating	Unit
Supply Voltage	Vcc	1.8~5.5	V
Input Voltage	VIN	0~Vcc	V

Status of this document

The Japanese version of this document is the formal specification.

A customer may use this translation version only for a reference to help reading the formal version.

If there are any differences in translation version of this document, formal version takes priority.

◇MEMORY CELL CHARACTERISTICS(Ta=25°C, Vcc=1.8~5.5V)

Parameter		Specification			Unit
		Min.	Typ.	Max.	
Write/Erase Cycle	*1	1,000,000	-	-	Cycle
Data Retention	*1	40	-	-	Year

○Initial Data: Memory array FFh, Status Register BP1:0, BP0:0
*1 Not 100% TESTED

◇ DC OPERATING CHARACTERISTICS
(Unless otherwise specified Ta=-40~85°C, Vcc=1.8~5.5V)

Parameter	Symbol	Specification			Unit	test condition
		Min.	Typ.	Max.		
"H" Input Voltage1	VIH1	0.7xVcc	-	Vcc+0.3	V	1.8V ≤ Vcc ≤ 5.5V
"L" Input Voltage1	VIL1	-0.3	-	0.3xVcc	V	1.8V ≤ Vcc ≤ 5.5V
"L" Output Voltage1	VOL1	0	-	0.4	V	IOL=2.1mA (Vcc=2.5V~5.5V)
"L" Output Voltage2	VOL2	0	-	0.2	V	IOL=150 μA (Vcc=1.8V~5.5V)
"H" Output Voltage1	VOH1	Vcc-0.5	-	Vcc	V	IOH=-0.4mA (Vcc=2.5V~5.5V)
"H" Output Voltage2	VOH2	Vcc-0.2	-	Vcc	V	IOH=-100 μA (Vcc=1.8V~5.5V)
Input Leakage Current	ILI	-1	-	1	μA	VIN=0V~Vcc
Output Leakage Current	ILO	-1	-	1	μA	VOUT=0V~Vcc, CS=Vcc
Operating Current Write	ICC1	-	-	1	mA	Vcc=1.8V, fSCK=2MHz, tE/W=5ms Byte Write, Page Write, Write Status Register
	ICC2	-	-	2	mA	Vcc=2.5V, fSCK=5MHz, tE/W=5ms Byte Write, Page Write, Write Status Register
	ICC3	-	-	3	mA	Vcc=5.5V, fSCK=5MHz, tE/W=5ms Byte Write, Page Write, Write Status Register
Operating Current Read	ICC4	-	-	1.5	mA	Vcc=2.5V, fSCK=5MHz Read, Read Status Register
	ICC5	-	-	2	mA	Vcc=5.5V, fSCK=5MHz Read, Read Status Register
Standby Current	ISB	-	-	2	μA	Vcc=5.5V CS=HOLD=WP=Vcc SCK=SI=Vcc or GND, SO=OPEN

○This product is not designed for protection against radioactive rays.

◇ AC OPERATING CHARACTERISTICS
(Unless otherwise specified Ta=-40~85°C, Ci=100pF)

Parameter	Symbol	1.8V ≤ Vcc ≤ 2.5V			2.5V ≤ Vcc ≤ 5.5V			Unit
		Min.	Typ.	Max.	Min.	Typ.	Max.	
SCK clock Frequency	fSCK	-	-	2	-	-	5	MHz
SCK High Time	tSCKWH	200	-	-	85	-	-	ns
SCK Low Time	tSCKWL	200	-	-	85	-	-	ns
CS High Time	tCS	200	-	-	85	-	-	ns
CS Setup Time	tCSS	200	-	-	90	-	-	ns
CS Hold Time	tCSH	200	-	-	85	-	-	ns
SCK Setup Time	tSOKS	200	-	-	90	-	-	ns
SCK Hold Time	tSOKH	200	-	-	90	-	-	ns
SI Setup Time	tDIS	40	-	-	20	-	-	ns
SI Hold Time	tDIH	50	-	-	40	-	-	ns
Output Data Delay Time1	tPD1	-	-	150	-	-	70	ns
Output Data Delay Time2 (Ci=30pF)	tPD2	-	-	145	-	-	55	ns
Output Hold Time	tOH	0	-	-	0	-	-	ns
Output Disable Time	tOZ	-	-	250	-	-	100	ns
Clock High Setup Time before HOLD Active	tHFS	120	-	-	60	-	-	ns
Clock Low Hold Time after HOLD Active	tHFH	90	-	-	40	-	-	ns
Clock High Setup Time before HOLD not Active	tHRS	120	-	-	60	-	-	ns
Clock Low Hold Time after HOLD not Active	tHRH	140	-	-	70	-	-	ns
HOLD to Output High-Z	tHOZ	-	-	250	-	-	100	ns
HOLD to Output Valid	tHPD	-	-	150	-	-	70	ns
SCK Rise Time *1	tRC	-	-	1	-	-	1	μs
SCK Fall Time *1	tFC	-	-	1	-	-	1	μs
Output Rise Time *1	tRO	-	-	100	-	-	50	ns
Output Fall Time *1	tFO	-	-	100	-	-	50	ns
Write Cycle Time	tE/W	-	-	5	-	-	5	ms

*1 Not 100% TESTED

◇ BLOCK DIAGRAM

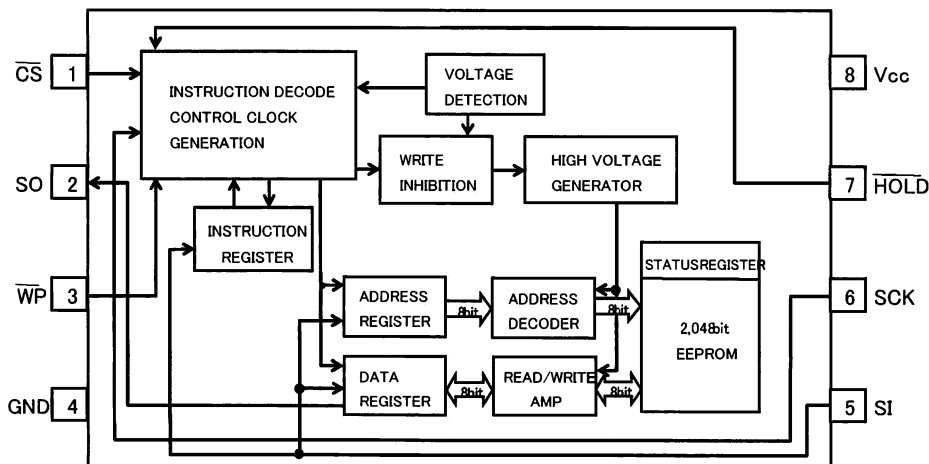

Fig.1 BLOCK DIAGRAM

◇ PIN No. / PIN NAME

PIN No.	PIN NAME
1	CS
2	SO
3	WP
4	GND
5	SI
6	SCK
7	HOLD
8	Vcc

◇NOTES FOR POWER SUPPLY

In order to prevent an inadvertent write, the device has the feature of P.O.R.

After the power is on, the device is in the write disable mode. P.O.R. works only during power up. The noise may force the device write enable mode with $\overline{CS} = "H"$ during power ON/OFF. In the case of power up, keep the following conditions to ensure to make the function of P.O.R.

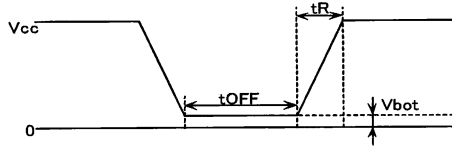

Fig.2 Vcc waveform

◇RECOMMENDED CONDITIONS OF tR, tOFF, Vbot

tR	tOFF	Vbot
Below 10ms	Above 10ms	Below 0.3V
Below 100ms	Above 10ms	Below 0.2V

Please keep \overline{CS} "H" during power ON/OFF.

The device is an active state during \overline{CS} is low. The extraordinary function or data collaption may occur because of noise etc., if power-up is done with \overline{CS} "L". In order to prevent above errors from happening, keep \overline{CS} "H" (=Vcc) during power ON. (The device does not receive any command during \overline{CS} is high.)

It may continue at low Vcc by capacitance of Vcc line during power off.

Please keep \overline{CS} "H" during power off because of the device may make malfunction and inadvertent write.

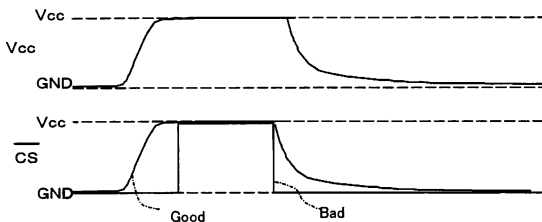

Fig.3 \overline{CS} TIMING DURING POWER ON/OFF

(Good example)

\overline{CS} follows Vcc. (\overline{CS} is pull up to Vcc)

(Bad example)

\overline{CS} is low during power ON/OFF.

Please take more than 10ms between power ON and power OFF, or the internal circuit is not always reset.

◇CAUTIONS ON USE

(1) Absolute maximum ratings

If the absolute maximum ratings such as impressed voltage and operating temperature range and so forth are exceeded, LSI may be destructed. Do not impress voltage and temperature exceeding the absolute maximum ratings. In the case of fear exceeding the absolute maximum ratings, take physical safety countermeasures such as fuses, and see to it that conditions exceeding the absolute maximum ratings should not be impressed to LSI.

(2) GND electric potential

Set the voltage of GND terminal lowest at any action condition. Make sure that each terminal voltages is lower than that of GND terminal.

(3) Heat design

In consideration of permissible dissipation in actual use condition, carry out heat design with sufficient margin.

(4) Terminal to terminal shortcircuit and wrong packaging

When to package LSI onto a board, pay sufficient attention to LSI direction and displacement. Wrong packaging may destruct LSI. And in the case of shortcircuit between LSI terminals and terminals and power source, terminal and GND owing to foreign matter, LSI may be destructed.

(5) Strong electromagnetic field

Use in a strong electromagnetic field may cause malfunction, therefore, evaluated design sufficiently.

◇PHYSICAL DIMENSION

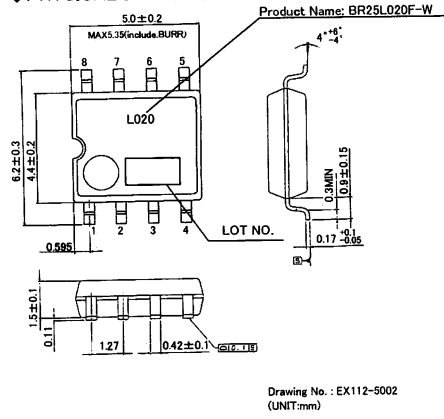

Fig4-(a) PHYSICAL DIMENSION
SOP8 (BR25L020F-W)

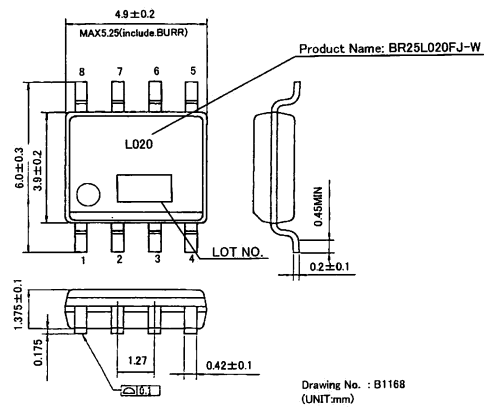

Fig4-(b) PHYSICAL DIMENSION
SOP-J8 (BR25L020FJ-W)

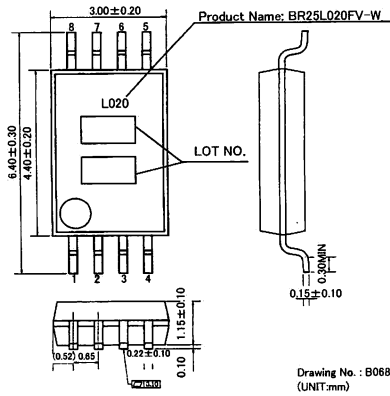

Fig4-(c) PHYSICAL DIMENSION
SSOP-B8 (BR25L020FV-W)

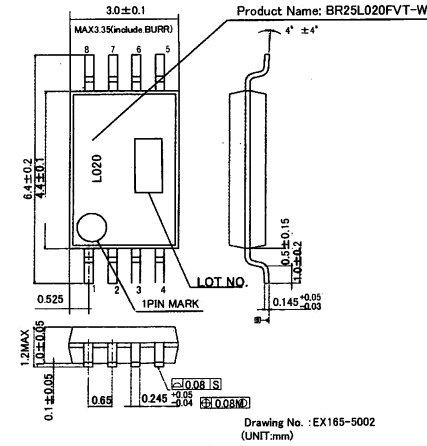

Fig4-(d) PHYSICAL DIMENSION
TSSOP-B8 (BR25L020FVT-W)

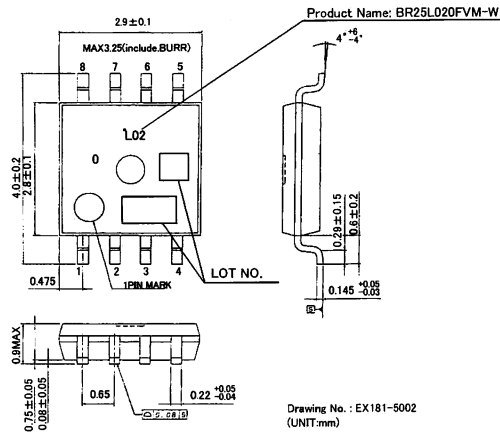

Fig4-(e) PHYSICAL DIMENSION
MSOP8 (BR25L020FVM-W)

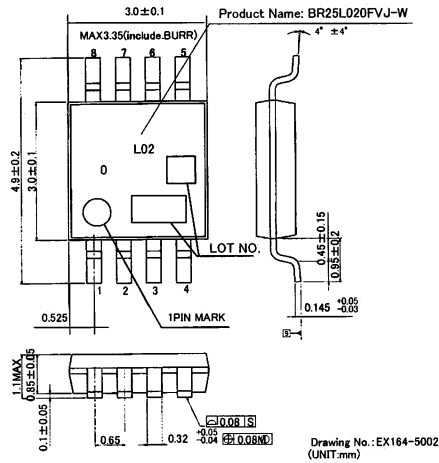

Fig4-(f) PHYSICAL DIMENSION
TSSOP-B8J (BR25L020FVJ-W)

Notes

- No technical content pages of this document may be reproduced in any form or transmitted by any means without prior permission of ROHM CO.,LTD.
- The contents described herein are subject to change without notice. The specifications for the product described in this document are for reference only. Upon actual use, therefore, please request that specifications to be separately delivered.
- Application circuit diagrams and circuit constants contained herein are shown as examples of standard use and operation. Please pay careful attention to the peripheral conditions when designing circuits and deciding upon circuit constants in the set.
- Any data, including, but not limited to application circuit diagrams information, described herein are intended only as illustrations of such devices and not as the specifications for such devices. ROHM CO.,LTD. disclaims any warranty that any use of such devices shall be free from infringement of any third party's intellectual property rights or other proprietary rights, and further, assumes no liability of whatsoever nature in the event of any such infringement, or arising from or connected with or related to the use of such devices.
- Upon the sale of any such devices, other than for buyer's right to use such devices itself, resell or otherwise dispose of the same, no express or implied right or license to practice or commercially exploit any intellectual property rights or other proprietary rights owned or controlled by
- ROHM CO., LTD. is granted to any such buyer.
- Products listed in this document are no antiradiation design.

The products listed in this document are designed to be used with ordinary electronic equipment or devices (such as audio visual equipment, office-automation equipment, communications devices, electrical appliances and electronic toys).

Should you intend to use these products with equipment or devices which require an extremely high level of reliability and the malfunction of which would directly endanger human life (such as medical instruments, transportation equipment, aerospace machinery, nuclear-reactor controllers, fuel controllers and other safety devices), please be sure to consult with our sales representative in advance.

About Export Control Order in Japan

Products described herein are the objects of controlled goods in Annex 1 (Item 16) of Export Trade Control Order in Japan.

In case of export from Japan, please confirm if it applies to "objective" criteria or an "informed" (by MITI clause) on the basis of "catch all controls for Non-Proliferation of Weapons of Mass Destruction.

Thank you for your accessing to ROHM product informations.
More detail product informations and catalogs are available,
please contact your nearest sales office.

Please contact our sales offices for details ;

U.S.A / San Diego	TEL : +1(858)625-3630	FAX : +1(858)625-3670
Atlanta	TEL : +1(770)754-5972	FAX : +1(770)754-0691
Dallas	TEL : +1(972)312-8818	FAX : +1(972)312-0330
Germany / Dusseldorf	TEL : +49(2154)9210	FAX : +49(2154)921400
United Kingdom / London	TEL : +44(1)908-282-666	FAX : +44(1)908-282-528
France / Paris	TEL : +33(0)1 56 97 30 60	FAX : +33(0) 1 56 97 30 80
China / Hong Kong	TEL : +852(2)740-6262	FAX : +852(2)375-8971
Shanghai	TEL : +86(21)6279-2727	FAX : +86(21)6247-2066
Dilian	TEL : +86(411)8230-8549	FAX : +86(411)8230-8537
Beijing	TEL : +86(10)8525-2483	FAX : +86(10)8525-2489
Taiwan / Taipei	TEL : +866(2)2500-6956	FAX : +866(2)2503-2869
Korea / Seoul	TEL : +82(2)8182-700	FAX : +82(2)8182-715
Singapore	TEL : +65-6332-2322	FAX : +65-6332-5662
Malaysia / Kuala Lumpur	TEL : +60(3)7958-8355	FAX : +60(3)7958-8377
Philippines / Manila	TEL : +63(2)807-6872	FAX : +63(2)809-1422
Thailand / Bangkok	TEL : +66(2)254-4890	FAX : +66(2)256-6334

Japan /
(Internal Sales)

Tokyo	2-1-1, Yaesu, Chuo-ku, Tokyo 104-0082	TEL : +81(3)5203-0321	FAX : +81(3)5203-0300
Yokohama	2-4-8, Shin Yokohama, Kohoku-ku, Yokohama, Kanagawa 222-8575	TEL : +81(45)476-2131	FAX : +81(45)476-2128
Nagoya	Dainagayo Building 9F 3-28-12, Meieki, Nakamura-ku, Nagoya, Aichi 450-0002	TEL : +81(52)581-8521	FAX : +81(52)561-2173
Kyoto	579-32 Higashi Shiokouji-cho, Karasuma Nishi-iru, Shiokoujidori, Shimogyo-ku, Kyoto 600-8216	TEL : +81(75)311-2121	FAX : +81(75)314-6559

(Contact address for overseas customers in Japan)

Yokohama	TEL : +81(45)476-9270	FAX : +81(045)476-9271
----------	-----------------------	------------------------