

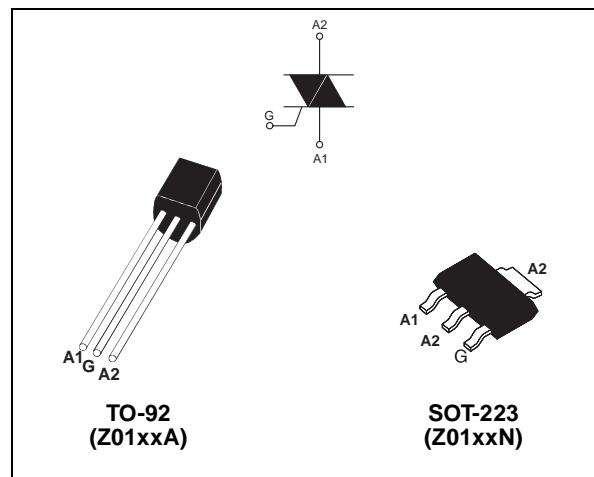
**MAIN FEATURES:**

Symbol	Value	Unit
$I_{T(RMS)}$	1	A
$V_{DRM}/V_{RRM}$	600 to 800	V
$I_{GT}(Q_1)$	3 to 25	mA

**DESCRIPTION**

The Z01 series is suitable for general purpose AC switching applications. They can be found in applications such as home appliances (electrovalve, pump, door lock, small lamp control), fan speed controllers,...

Different gate current sensitivities are available, allowing optimized performances when controlled directly from microcontrollers.


**ABSOLUTE MAXIMUM RATINGS**

Symbol	Parameter		Value	Unit
$I_{T(RMS)}$	RMS on-state current (full sine wave)	SOT-223 $T_{tab} = 90^{\circ}C$	1	A
		TO-92 $T_I = 50^{\circ}C$		
$I_{TSM}$	Non repetitive surge peak on-state current (full cycle, $T_j$ initial = $25^{\circ}C$ )	F = 50 Hz t = 20 ms	8	A
		F = 60 Hz t = 16.7 ms	8.5	
$I^2t$	$I^2t$ Value for fusing	tp = 10 ms	0.35	$A^2s$
dl/dt	Critical rate of rise of on-state current $I_G = 2 \times I_{GT}$ , $t_r \leq 100$ ns	F = 120 Hz $T_j = 125^{\circ}C$	20	A/ $\mu s$
$I_{GM}$	Peak gate current	tp = 20 $\mu s$ $T_j = 125^{\circ}C$	1	A
$P_{G(AV)}$	Average gate power dissipation	$T_j = 125^{\circ}C$	0.1	W
$T_{stg}$ $T_j$	Storage junction temperature range Operating junction temperature range		- 40 to + 150 - 40 to + 125	$^{\circ}C$

## Z01 Series

### ELECTRICAL CHARACTERISTICS (T<sub>j</sub> = 25°C, unless otherwise specified)

Symbol	Test Conditions	Quadrant		Z01xx				Unit
				03	07	09	10	
I <sub>GT</sub> (1)	V <sub>D</sub> = 12 V    R <sub>L</sub> = 30 Ω	I - II - III IV	MAX.	3 5	5 7	10 10	25 25	mA
V <sub>GT</sub>		ALL	MAX.	1.3				V
V <sub>GD</sub>	V <sub>D</sub> = V <sub>DRM</sub> R <sub>L</sub> = 3.3 kΩ    T <sub>j</sub> = 125°C	ALL	MIN.	0.2				V
I <sub>H</sub> (2)	I <sub>T</sub> = 50 mA		MAX.	7	10	10	25	mA
I <sub>L</sub>	I <sub>G</sub> = 1.2 I <sub>GT</sub>	I - III - IV	MAX.	7	10	15	25	mA
		II		15	20	25	50	
dV/dt (2)	V <sub>D</sub> = 67 %V <sub>DRM</sub> gate open    T <sub>j</sub> = 110°C		MIN.	10	20	50	100	V/μs
(dV/dt) <sub>c</sub> (2)	(dI/dt) <sub>c</sub> = 0.44 A/ms    T <sub>j</sub> = 110°C		MIN.	0.5	1	2	5	V/μs

### STATIC CHARACTERISTICS

Symbol	Test Conditions		Value	Unit	
V <sub>TM</sub> (2)	I <sub>TM</sub> = 1.4 A    t <sub>p</sub> = 380 μs	T <sub>j</sub> = 25°C	MAX.	1.6	V
V <sub>to</sub> (2)	Threshold voltage	T <sub>j</sub> = 125°C	MAX.	0.95	V
R <sub>d</sub> (2)	Dynamic resistance	T <sub>j</sub> = 125°C	MAX.	400	mΩ
I <sub>DRM</sub> I <sub>RDM</sub>	V <sub>DRM</sub> = V <sub>RRM</sub>	T <sub>j</sub> = 25°C	MAX.	5	μA
		T <sub>j</sub> = 125°C		0.5	mA

**Note 1:** minimum I<sub>GT</sub> is guaranteed at 5% of I<sub>GT</sub> max.

**Note 2:** for both polarities of A2 referenced to A1

### THERMAL RESISTANCES

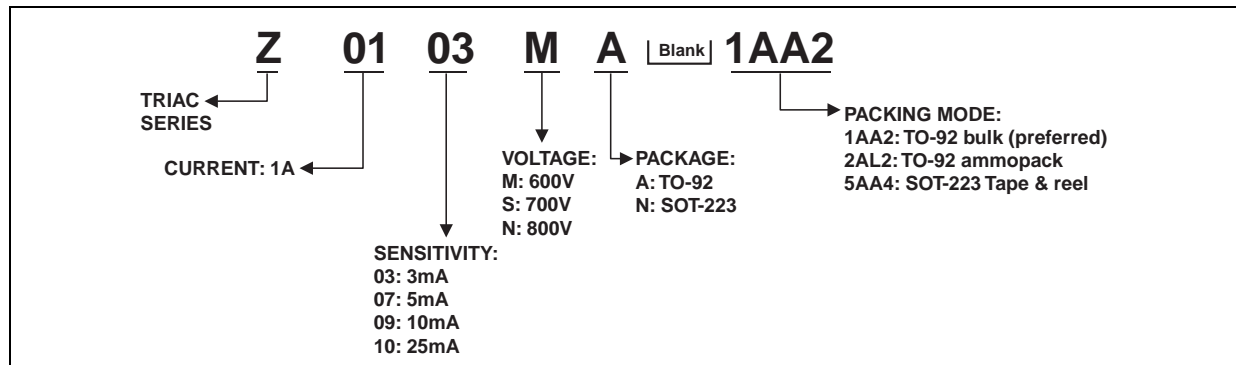
Symbol	Parameter		Value	Unit	
R <sub>th(j-t)</sub>	Junction to tab (AC)		SOT-223	25	°C/W
R <sub>th(j-l)</sub>	Junction to lead (AC)		TO-92	60	
R <sub>th(j-a)</sub>	Junction to ambient	S = 5 cm <sup>2</sup>	SOT-223	60	°C/W
			TO-92	150	

S = Copper surface under tab

**PRODUCT SELECTOR**

Part Number	Voltage			Sensitivity	Type	Package
	600 V	700 V	800 V			
Z0103MA	X			3 mA	Standard	TO-92
Z0103MN	X			3 mA	Standard	SOT-223
Z0103SA		X		3 mA	Standard	TO-92
Z0103SN		X		3 mA	Standard	SOT-223
Z0103NA			X	3 mA	Standard	TO-92
Z0103NN			X	3 mA	Standard	SOT-223
Z0107MA	X			5 mA	Standard	TO-92
Z0107MN	X			5 mA	Standard	SOT-223
Z0107SA		X		5 mA	Standard	TO-92
Z0107SN		X		5 mA	Standard	SOT-223
Z0107NA			X	5 mA	Standard	TO-92
Z0107NN			X	5 mA	Standard	SOT-223
Z0109MA	X			10 mA	Standard	TO-92
Z0109MN	X			10 mA	Standard	SOT-223
Z0109SA		X		10 mA	Standard	TO-92
Z0109SN		X		10 mA	Standard	SOT-223
Z0109NA			X	10 mA	Standard	TO-92
Z0109NN			X	10 mA	Standard	SOT-223
Z0110MA	X			25 mA	Standard	TO-92
Z0110MN	X			25 mA	Standard	SOT-223
Z0110SA		X		25 mA	Standard	TO-92
Z0110SN		X		25 mA	Standard	SOT-223
Z0110NA			X	25 mA	Standard	TO-92
Z0110NN			X	25 mA	Standard	SOT-223

**ORDERING INFORMATION**



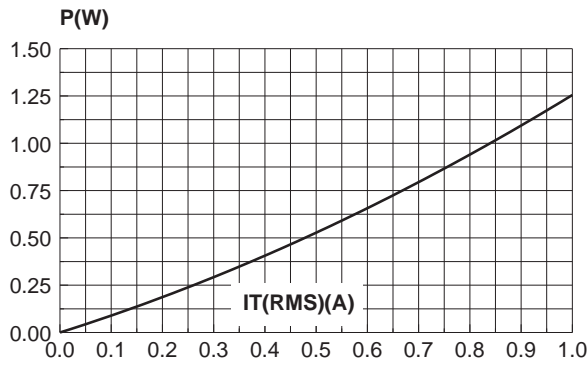
# Z01 Series

## OTHER INFORMATION

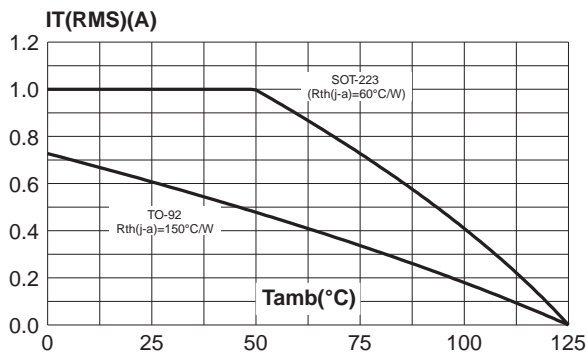
Part Number	Marking	Weight	Base quantity	Packing mode
Z01xyA 1AA2	Z01xyA	0.2 g	2500	Bulk
Z01xyA 2AL2	Z01xyA	0.2 g	2000	Ammopack
Z0103yN 5AA4	Z3y	0.12 g	1000	Tape & reel
Z0107yN 5AA4	Z7y	0.12 g	1000	Tape & reel
Z0109yN 5AA4	Z9y	0.12 g	1000	Tape & reel
Z0110yN 5AA4	Z0y	0.12 g	1000	Tape & reel

Note: xx = sensitivity, y = voltage

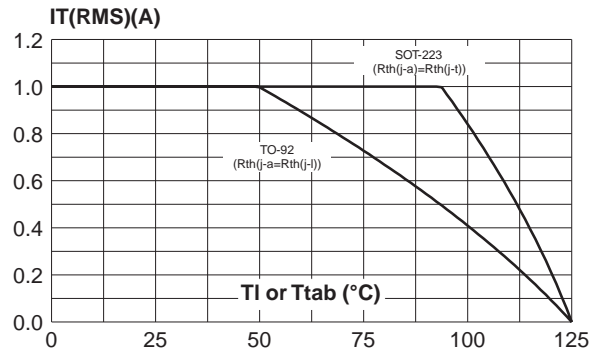
**Fig. 1:** Maximum power dissipation versus RMS on-state current (full cycle).



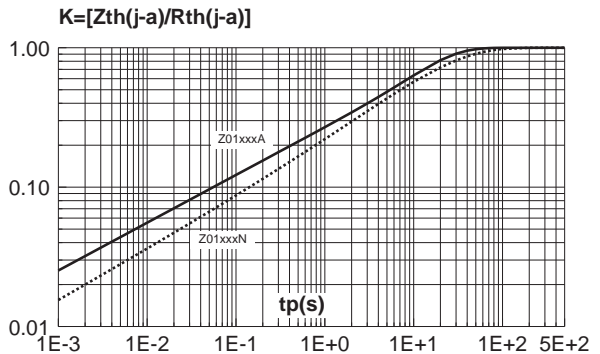
**Fig. 2-2:** RMS on-state current versus ambient temperature (full cycle).



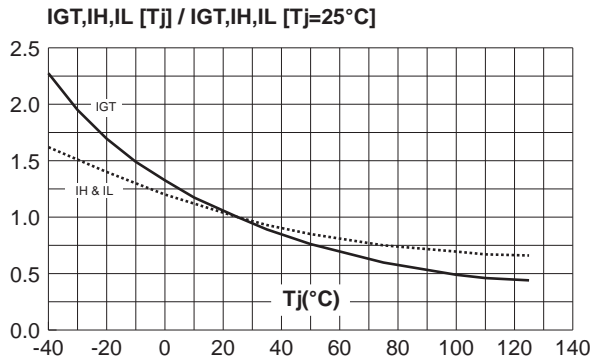
**Fig. 2-1:** RMS on-state current versus ambient temperature (full cycle).



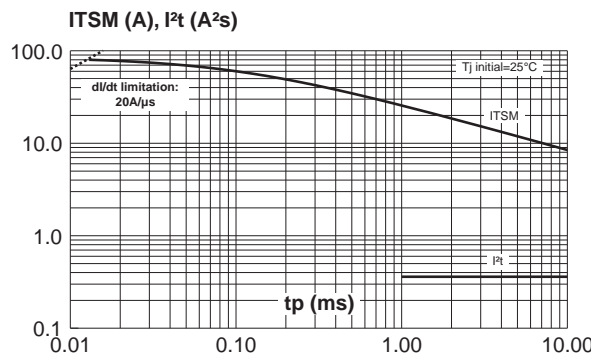
**Fig. 3:** Relative variation of thermal impedance junction to ambient versus pulse duration.



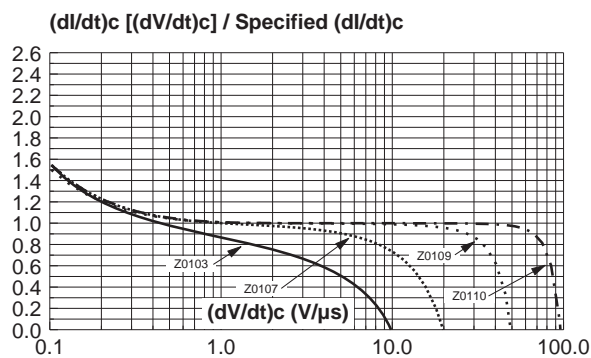
**Fig. 4:** Relative variation of gate trigger current, holding current and latching current versus junction temperature (typical values).



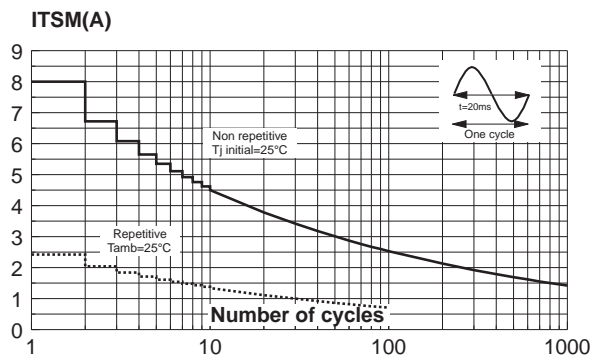
**Fig. 6:** Non-repetitive surge peak on-state current for a sinusoidal pulse with width  $t_p < 10\text{ms}$ , and corresponding value of  $I^2t$ .



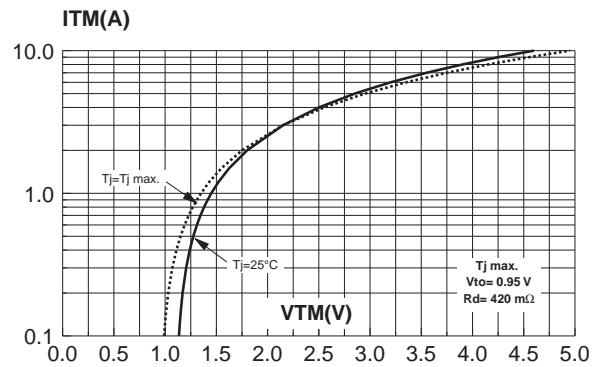
**Fig. 8:** Relative variation of critical rate of decrease of main current versus  $(dV/dt)_c$  (typical values).



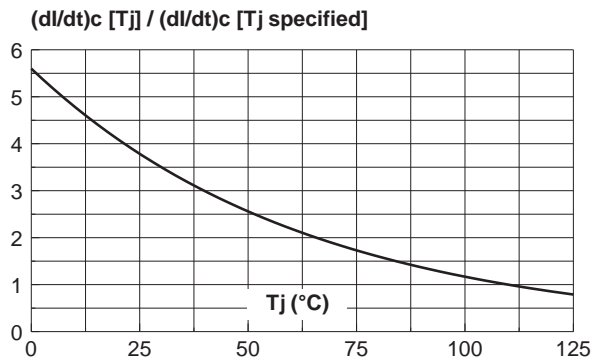
**Fig. 5:** Surge peak on-state current versus number of cycles.



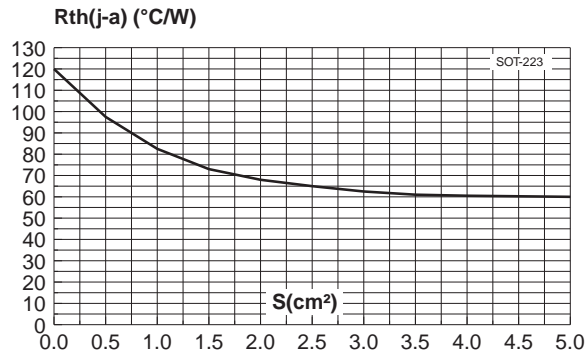
**Fig. 7:** On-state characteristics (maximum values).



**Fig. 9:** Relative variation of critical rate of decrease of main current versus junction temperature.

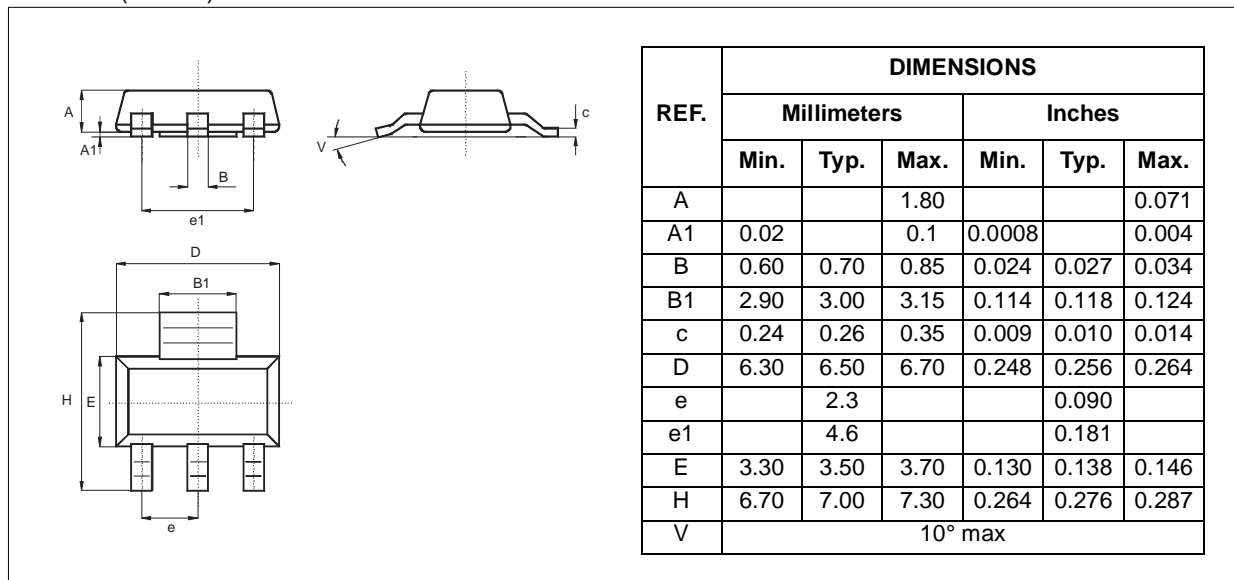


**Fig. 10:** SOT-223 Thermal resistance junction to ambient versus copper surface under tab (printed circuit board FR4, copper thickness: 35µm).



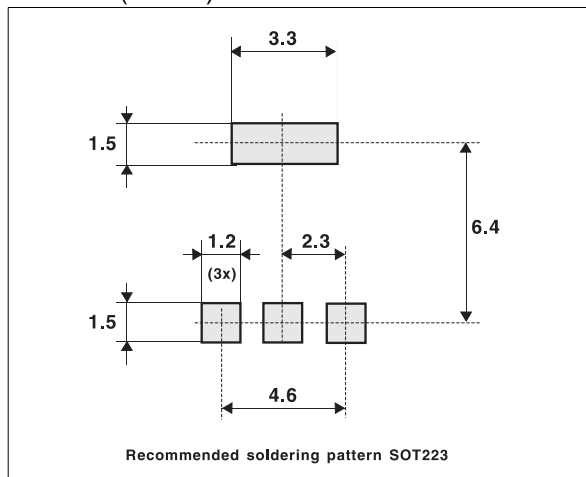
**PACKAGE MECHANICAL DATA**

SOT-223 (Plastic)



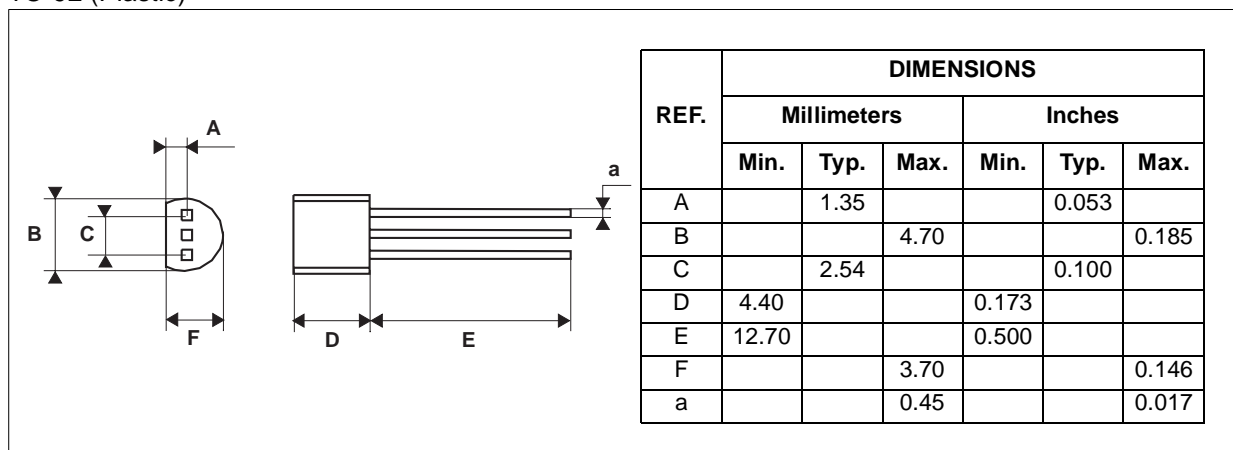
**FOOTPRINT DIMENSIONS** (in millimeters)

SOT-223 (Plastic)



**PACKAGE MECHANICAL DATA**

TO-92 (Plastic)



Information furnished is believed to be accurate and reliable. However, STMicroelectronics assumes no responsibility for the consequences of use of such information nor for any infringement of patents or other rights of third parties which may result from its use. No license is granted by implication or otherwise under any patent or patent rights of STMicroelectronics. Specifications mentioned in this publication are subject to change without notice. This publication supersedes and replaces all information previously supplied. STMicroelectronics products are not authorized for use as critical components in life support devices or systems without express written approval of STMicroelectronics.

© The ST logo is a registered trademark of STMicroelectronics

© 2003 STMicroelectronics - Printed in Italy - All Rights Reserved

STMicroelectronics GROUP OF COMPANIES

Australia - Brazil - China - Finland - France - Germany - Hong Kong - India - Italy - Japan - Malaysia  
Malta - Morocco - Singapore - Spain - Sweden - Switzerland - United Kingdom - U.S.A

<http://www.st.com>

